

1



FN035-6EA.0C.A7P2 | 155894 | Portfolio Europe | FE2owlet AC

Technical Description FE2owlet

Range FN

Standard design with AC-motor

- Profiled, sickle shaped blades designed with bionical know how
- Sizes 310 ... 800 mm (in 9 standard sizes)
- Optimized for full bell mouth
- 100% speed controllable
- ZIEHL-ABEGG FE2owlet fans can be used from -40°C* up to 70°C.

Mains voltage:

- 3~ zweitourig 400 V ±10% D/Y
- 3~ zweitourig 400/460 V ±10% D/Y

Frequenz:

- 50 Hz
- 60 Hz

Thermal class:

- THCL 155

Protection:

- IP54

Motor protection:

- Thermostat relay (TB)

Material of impeller:

- Aluminium die-cast

Painting:

- Fan in color RAL 9005 deep black
- Wall ring plate and suspension in color RAL 9005 deep black

On request:

- Different paintings
- Fan designs

***Continuous operation with occasional starts (S1) according to DIN EN 60034-1: 2011-02. Occasional starting between -35 ° C and -25 ° C is permissible. Permanent operation below -25 ° C only possible with special bearings for refrigeration applications on request.**



données ventilateur

07.10.2024

Version FANselect V 1.01 (241007), AMCA V 1.03 September, 2021
 RLT V 1.00 Dezember, 2021 / 1.24.10.07 | 35883 | (utilisateur ZAFS25883)



type	FN035-6EA.0C.A7P2	
n°article	155894 Portfolio Europe	
note	-	conception "A" - s'il vous plaît vérifier composants supplémentaires

caractéristiques

moteur		AC
tension principale	-	1~ 230V 50Hz
intensité nominale (I_N)	A	0.39
condensateur (C_{400V})	μF	3.0
température ambiante (t_r)	$^{\circ}C$	70
classe ErP		< 125W
grille influence		without

données ventilateur

vitesse ventilateur (n) max. (n_{max})	1/min	- 952
frequence (f_{BP}) (f_{max})	Hz	50 60
dimensions (Lxlxh)	mm	353 x 353 x 178
poids (m_{pr})	kg	3.3

PF:PF_61; Ano:155894; STol:+10 %



courbe debit/pression / Acoustic

07.10.2024

Version FANselect V 1.01 (241007), AMCA V 1.03 September, 2021
 RLT V 1.00 Dezember, 2021 / 1.24.10.07 | 35883 | (utilisateur ZAFS25883)

1

FN035-6EA.0C.A7P2

Measured in full nozzle without guard grille in air flow direction V in installation type A according to ISO5801

155894 | Portfolio Europe

densité de mesure 1.19 [kg/m³]

Performance aéraulique p_{sF}

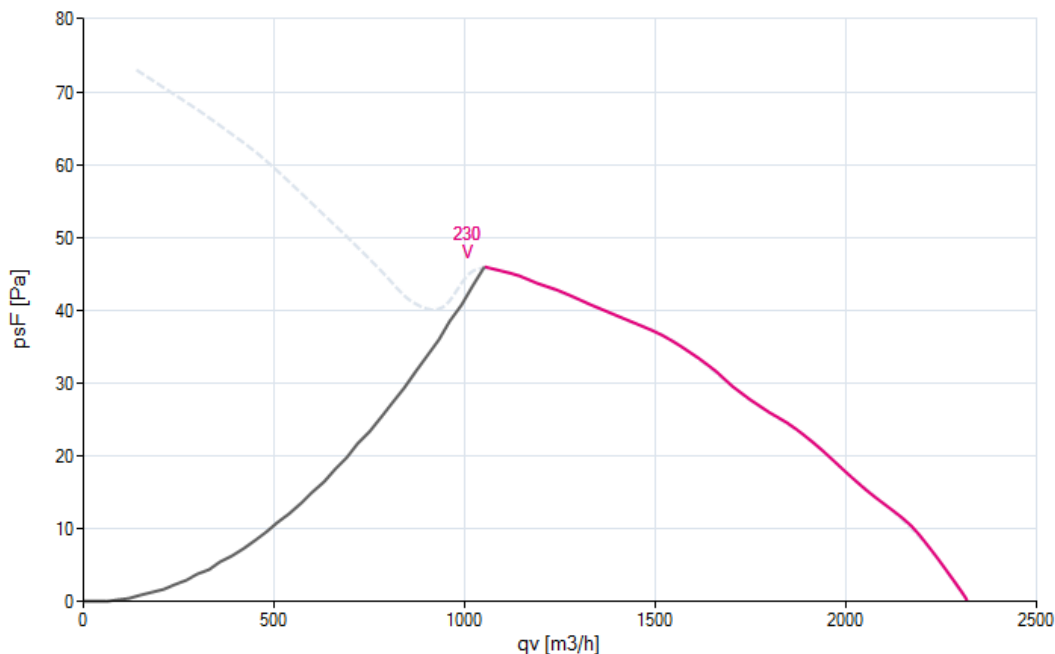

niveau de puissance acoustique côté aspiration-pondérées A (Niveau de puissance acoustique côté refoulement-pondérées A ($L_{w(A),6}$))

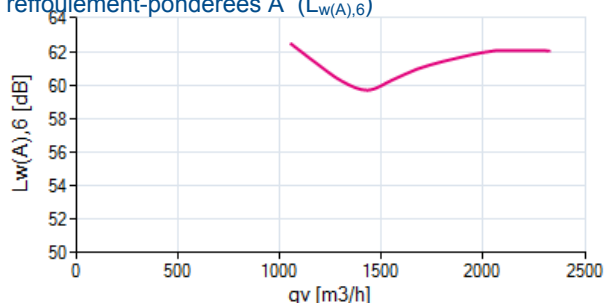
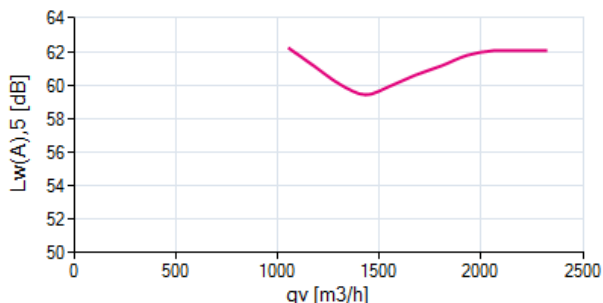

1 FN035-6EA.0C.A7P2

f [Hz]	sum	63	125	250	500	1000	2000	4000	8000
$L_{w(A),5}$	-	-	-	-	-	-	-	-	-
$L_{w,5}$	-	-	-	-	-	-	-	-	-

f [Hz]	sum	63	125	250	500	1000	2000	4000	8000
$L_{w(A),6}$	-	-	-	-	-	-	-	-	-
$L_{w,6}$	-	-	-	-	-	-	-	-	-

FANselect



rendement / puissance

07.10.2024

Version FANselect V 1.01 (241007), AMCA V 1.03 September, 2021
 RLT V 1.00 Dezember, 2021 / 1.24.10.07 | 35883 | (utilisateur ZAFS25883)

1

FN035-6EA.0C.A7P2

Measured in full nozzle without guard grille in air flow direction V in installation type A according to ISO5801

155894 | Portfolio Europe

densité de mesure 1.19 [kg/m³]

rendement η_F

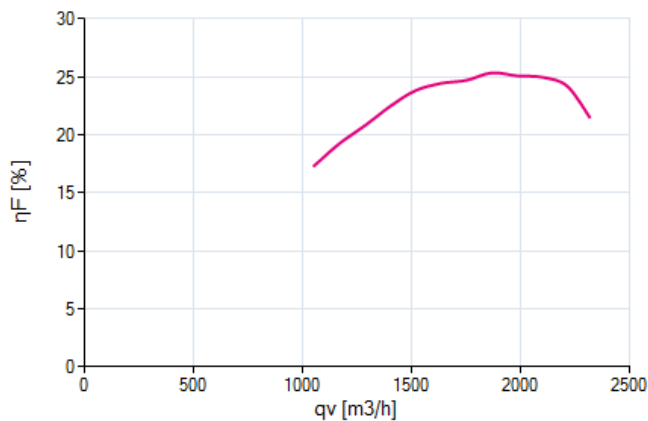

rendement η_{sF}

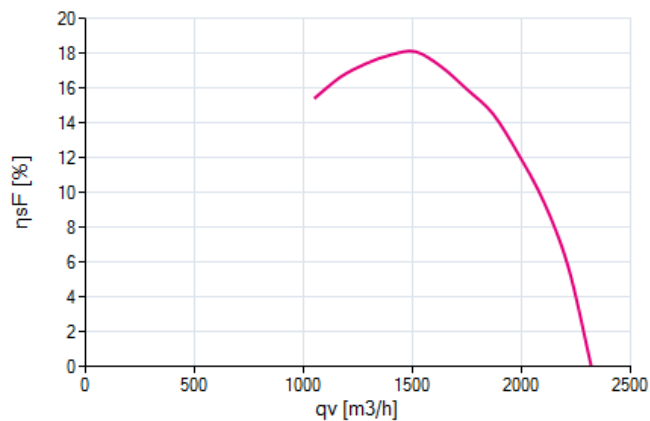

puissance P_1

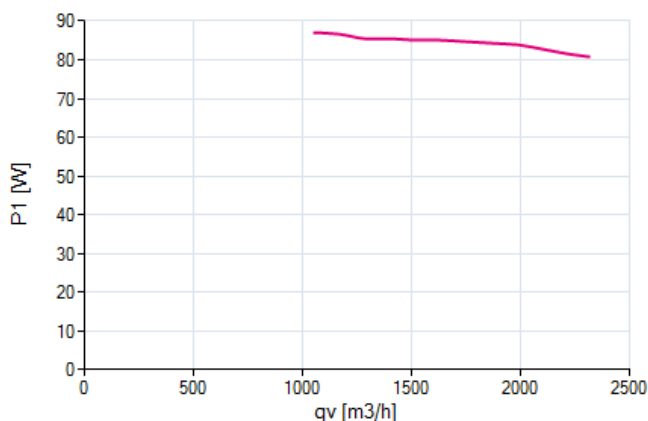



FANselect

valeur nominale

version FANselect V 1.01 (241007), AMCA V 1.03 September, 2021
RLT V 1.00 Dezember, 2021 / 1.24.10.07 | 35883 | (utilisateur ZAFS25883) 07.10.2024

1



FN035-6EA.0C.A7P2

155894

1~ 230V +10/-10 50Hz P1 0.085kW
 0.39A DI=0% 930/MIN 3.0µF/400V 70°C
 1~ 230V +10/-10 60Hz P1 0.12kW
 0.52A DI=0% 1060/MIN 3.0µF/400V 70°C
 IP54 THCL155

plan

version FANselect V 1.01 (241007), AMCA V 1.03 September, 2021
RLT V 1.00 Dezember, 2021 / 1.24.10.07 | 35883 | (utilisateur ZAFS25883) 07.10.2024

1



FN035-6EA.0C.A7P2

155894



schéma de bobinage

version FANselect V 1.01 (241007), AMCA V 1.03 September, 2021
RLT V 1.00 Dezember, 2021 / 1.24.10.07 | 35883 | (utilisateur ZAFS25883) 07.10.2024

1

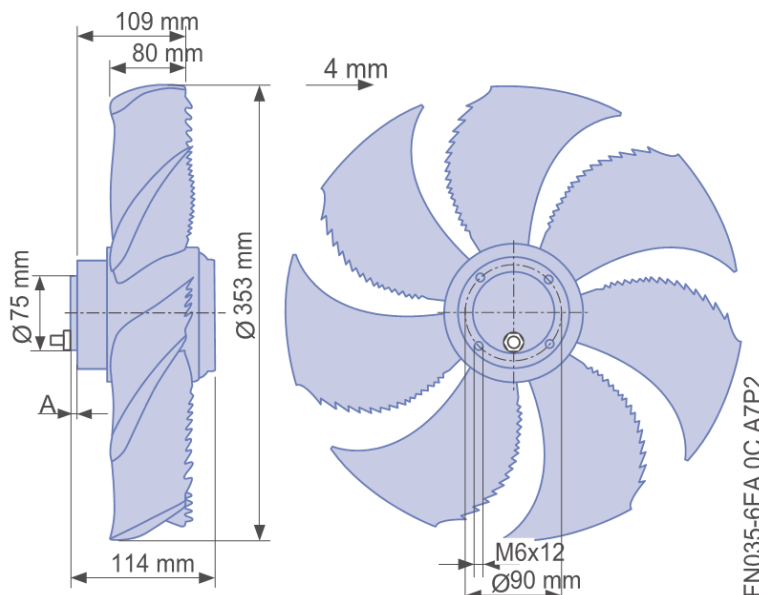

FN035-6EA.0C.A7P2

155894

1-Motor mit Kondensator und Thermostatschalter.
 1-Motor with capacitor and thermostatic switch.
 Moteur monophasé avec condensateur et interrupteur thermostatique.

UZ	blau oder grau	blue or grey	bleu ou gris
Z2	schwarz	black	noir
TB	braun	brown	brun



Anschlussschaltbild im Anschlusskasten aufbewahren.
 Keep wiring diagram in terminal box.
 Conserver le schéma de raccordement dans la boîte à bornes.



accessoires system

07.10.2024

Version FANselect V 1.01 (241007), AMCA V 1.03 September, 2021
 RLT V 1.00 Dezember, 2021 / 1.24.10.07 | 35883 | (utilisateur ZAFS25883)



type	FN035-6EA.0C.A7P2
n°article	155894

accessoires mécaniques	logement de condensateur type: GC3 n°article: 00264065
	logement de condensateur type: GC10 n°article: 00264071
	logement de condensateur type: GC12 n°article: 00264072
	logement de condensateur type: GC2 n°article: 00264073
	logement de condensateur type: GC14 n°article: 00264074
	logement de condensateur type: GC1,5 n°article: 00266159
	logement de condensateur type: GC16 n°article: 00308236