

1



FN045-6EW.2F.A7P3 | 160038 | Portfolio Europe | FE2owlet AC

Technical Description FE2owlet

## Range FN

### Standard design with AC-motor

- Profiled, sickle shaped blades designed with bionical know how
- Sizes 310 ... 800 mm (in 9 standard sizes)
- Optimized for full bell mouth
- 100% speed controllable
- ZIEHL-ABEGG FE2owlet fans can be used from -40°C\* up to 70°C.

### Mains voltage:

- 3~ zweitourig 400 V ±10% D/Y
- 3~ zweitourig 400/460 V ±10% D/Y

### Frequenz:

- 50 Hz
- 60 Hz

### Thermal class:

- THCL 155

### Protection:

- IP54

### Motor protection:

- Thermostat relay (TB)

### Material of impeller:

- Aluminium die-cast

### Painting:

- Fan in color RAL 9005 deep black
- Wall ring plate and suspension in color RAL 9005 deep black

### On request:

- Different paintings
- Fan designs

**\*Continuous operation with occasional starts (S1) according to DIN EN 60034-1: 2011-02. Occasional starting between -35 ° C and -25 ° C is permissible. Permanent operation below -25 ° C only possible with special bearings for refrigeration applications on request.**



## données ventilateur

01.03.2024

Version FANselect V 1.01 (240301), AMCA V 1.03 September, 2021 <br> RLT V 1.00 Dezember, 2021 / 1.24.03.01 | 35883 | (utilisateur ZAFS25883)



type	<b>FN045-6EW.2F.A7P3</b>
n°article	160038   Portfolio Europe

### caractéristiques

moteur		AC
tension principale	-	1~ 230V 50Hz
intensité nominale (I <sub>N</sub> )	A	0.50
condensateur (C <sub>400V</sub> )	µF	3.0
température ambiante (t <sub>r</sub> )	°C	70
classe ErP		< 125W
grille   influence		pressure side   not measured

### données ventilateur

vitesse ventilateur (n)   max. (n <sub>max</sub> )	1/min	-   835
frequence (f <sub>BP</sub> )   (f <sub>max</sub> )	Hz	<b>50</b>   60
dimensions (Lxlxh)	mm	544 x 544 x 186
poids (m <sub>pr</sub> )	kg	6.3

PF:PF\_61; Ano:160038; STol:+-10 %



## courbe debit/pression / Acoustic

01.03.2024

Version FANselect V 1.01 (240301), AMCA V 1.03 September, 2021 <br> RLT V 1.00 Dezember, 2021 / 1.24.03.01 | 35883 | (utilisateur ZAFS25883)

1

**FN045-6EW.2F.A7P3**

Measured in full nozzle without guard grille in air flow direction V in installation type A according to ISO5801

160038 | Portfolio Europe

densité de mesure 1.18 [kg/m³]

### Performance aéraulique $p_{sF}$

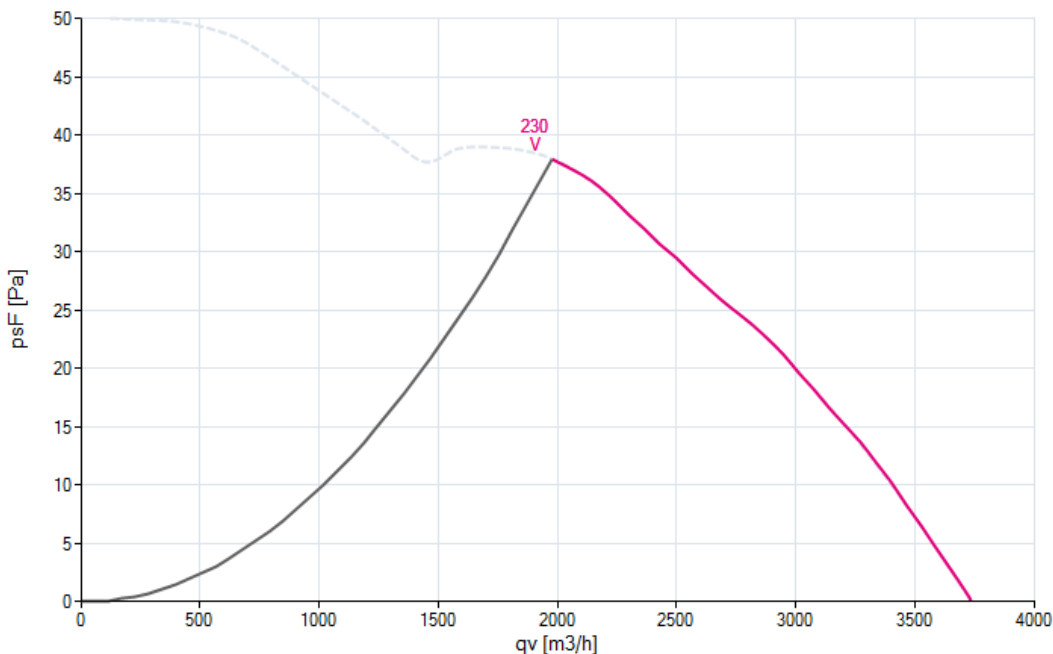

### niveau de puissance acoustique côté aspiration-pondérées A (Niveau de puissance acoustique côté reffoulement-pondérées A ( $L_{w(A),6}$ ))

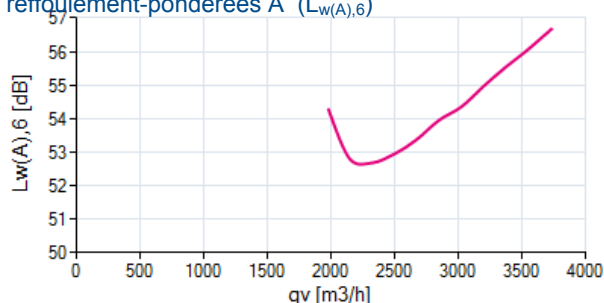
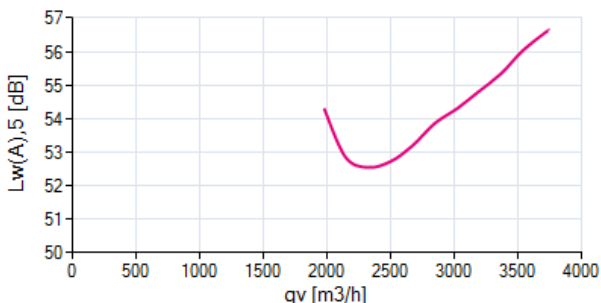

1 FN045-6EW.2F.A7P3

f [Hz]	sum	63	125	250	500	1000	2000	4000	8000
$L_{w(A),5}$	-	-	-	-	-	-	-	-	-
$L_{w,5}$	-	-	-	-	-	-	-	-	-

f [Hz]	sum	63	125	250	500	1000	2000	4000	8000
$L_{w(A),6}$	-	-	-	-	-	-	-	-	-
$L_{w,6}$	-	-	-	-	-	-	-	-	-

# FANselect



## rendement / puissance

01.03.2024

Version FANselect V 1.01 (240301), AMCA V 1.03 September, 2021 <br> RLT V 1.00 Dezember, 2021 / 1.24.03.01 | 35883 | (utilisateur ZAFS25883)

1

FN045-6EW.2F.A7P3

Measured in full nozzle without guard grille in air flow direction V in installation type A according to ISO5801

160038 | Portfolio Europe

densité de mesure 1.18 [kg/m³]

rendement  $\eta_F$

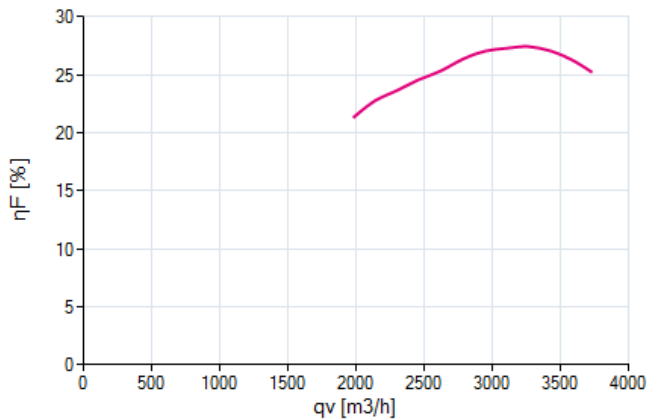

rendement  $\eta_{sF}$

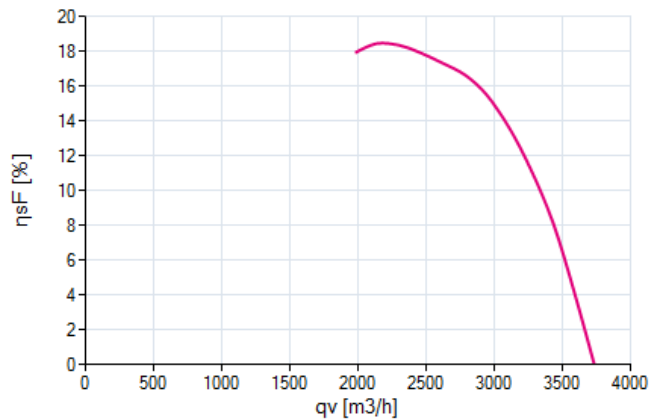

puissance  $P_1$

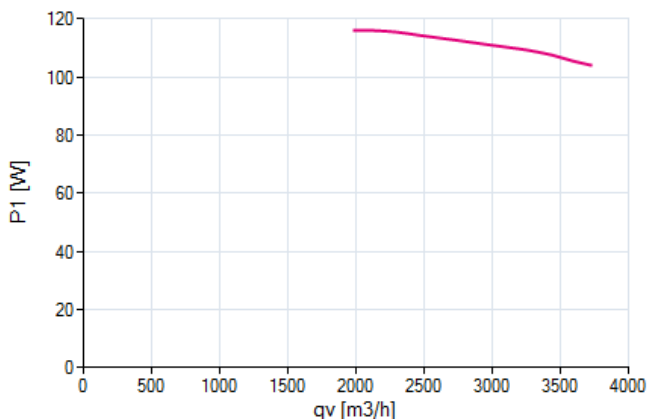



# FANselect

## valeur nominale

01.03.2024

version FANselect V 1.01 (240301), AMCA V 1.03 September, 2021<br>RLT V 1.00 Dezember, 2021 / 1.24.03.01 | 35883 | (utilisateur ZAFS25883)

1



**FN045-6EW.2F.A7P3**

160038

1~ 230V +10/-10 50Hz P1 0.12kW P2 0.05kW  
 0.50A DI=0% 700/MIN 3.0µF/400V 70°C  
 1~ 230V +10/-10 60Hz P1 0.14kW P2 0.05kW  
 0.60A DI=0% 640/MIN 3.0µF/400V 70°C  
 IP54 THCL155

## plan

01.03.2024

version FANselect V 1.01 (240301), AMCA V 1.03 September, 2021<br>RLT V 1.00 Dezember, 2021 / 1.24.03.01 | 35883 | (utilisateur ZAFS25883)

1



**FN045-6EW.2F.A7P3**

160038

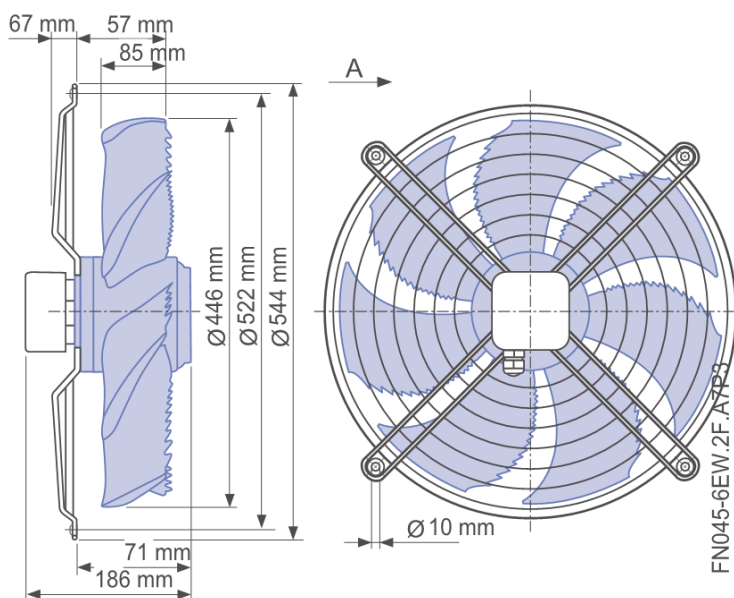

## schéma de bobinage

01.03.2024

version FANselect V 1.01 (240301), AMCA V 1.03 September, 2021<br>RLT V 1.00 Dezember, 2021 / 1.24.03.01 | 35883 | (utilisateur ZAFS25883)

1



**FN045-6EW.2F.A7P3**

160038

1-Motor mit Kondensator und Thermostatschalter.  
 1-Motor with capacitor and thermostatic switch.  
 Moteur monophasé avec condensateur et interrupteur thermostatique.

U2	blau oder grau	blue or grey	bleu ou gris
Z2	schwarz	black	noir
TB	braun	brown	brun



Anschlussschaltbild im Anschlusskasten aufbewahren.  
 Keep wiring diagram in terminal box.  
 Conserver le schéma de raccordement dans la boîte à bornes.



## accessoires system

01.03.2024

Version FANselect V 1.01 (240301), AMCA V 1.03 September, 2021 <br> RLT V 1.00 Dezember, 2021 / 1.24.03.01 | 35883 | (utilisateur ZAFS25883)



type	<b>FN045-6EW.2F.A7P3</b>
n°article	160038



## Series

FN

## Design

FE2owlet

## Specification

- Direct-driven axial fan
- Aerodynamic-optimised, sickle-blade profile, patterned with serrated trailing edge and winglets on the blade outer edge for energy and noise-optimised operation
- External rotor motor with innovative bionic blade in die-cast aluminium or composite injection moulded
- Impeller: Ø 200 – 1.250 mm
- Balanced in Class G 6.3 acc DIN ISO 21940, dynamic on two levels.
- Any fitting position
- Drive motor in external rotor principle, sealed in protection class IP54 with moisture protection impregnation of the winding, tropical protection
- Thermal contact installed in the winding compliant with THCL 155.
- The permissible ambient temperature is -40°C\* to max. +70°C (see data sheet)
- Maintenance-free ball bearings sealed on both sides with long-term lubrication
- Fan characteristic curve refer to measurements made on a combined air performance and acoustic test rig according DIN EN ISO 5801, or AMCA 210-99
- Make the electrical connection according to the operating instructions

## System components

Guard grille, inlet rings, control technology

## Technical data

<b>Fan type</b>	_____	
<b>Fan size (Ø)</b>	_____	mm
<b>Design</b>	_____	
<b>Air flow (q<sub>v</sub>)</b>	_____	m <sup>3</sup> /h
<b>Static pressure rise (Δp<sub>sF</sub>)</b>	_____	Pa
<b>Rated voltage (U)</b>	_____	V
<b>Mains frequency (f)</b>	_____	Hz
<b>Rated power (P<sub>N</sub>)</b>	_____	kW
<b>Efficiency (η<sub>sF</sub>)</b>	_____	%
<b>Rated speed (n)</b>	_____	min <sup>-1</sup>
<b>Media temperature (t<sub>R</sub>)</b>	_____	°C
<b>Sound power level (L<sub>WA</sub>)</b>	_____	dB(A)
<b>Weight (m)</b>	_____	kg

### Bauformen

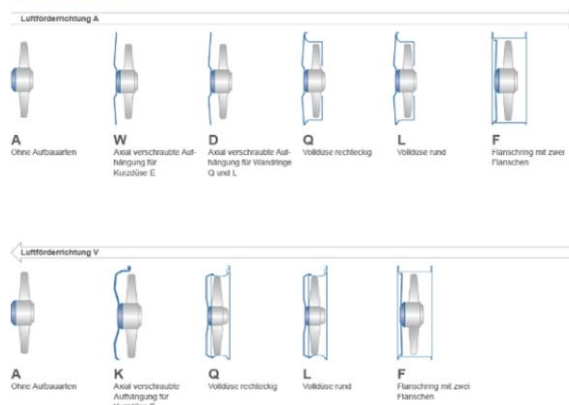

Further designs on request

All frame sizes are available in various grill and nozzle versions (designs).

\*Continuous operation with occasional starts (S1) according to DIN EN 60034-1: 2011-02. Occasional starting between -35 ° C and -25 ° C is permissible. Permanent operation below -25 ° C only possible with special bearings for refrigeration applications on request.

# FANselect



<b>LCC</b>	01.03.2024
version FANselect V 1.01 (240301), AMCA V 1.03 September, 2021   RLT V 1.00 Dezember, 2021 / 1.24.03.01   35883   (utilisateur ZAFS25883)	

type n°article  
1 FN045-6EW.2F.A7P3 160038

	1
--	---

coût		
1 année	EUR	0
2 année	EUR	0
3 année	EUR	0
4 année	EUR	0
5 année	EUR	0

chargement profile			
heure	% Vitesse / débit		
1000	100	%	
1000	50	%	
1000	25	%	
		%	
5760	Temps heures		
Coût energie	0.10	EUR/kWh	
niveau de prix	00	%	

